

CONGRATULATIONS!

Like thousands of Display owners around the world, you now own the highest quality portable/modular display. Your Instand® is specially designed to give you the ultimate in versatility. Classic (curved) and Plus (straight) frame systems fully integrate to meet your growing exhibit demands. And your 100% satisfaction is guaranteed.



The “No Questions Asked” Lifetime Warranty

Your Instand frame is guaranteed for life. If it ever fails to function — for any reason — We will repair it free of charge for as long as you own it. Be sure to complete and return the enclosed warranty card immediately.

Made to Last

Superior in design and strength, your Instand Display is built in manufacturing plants in the U.S. and Ireland. We use only premium grade materials and take pride in maintaining the highest standards of craftsmanship. Your display is delivered to you packed for maximum protection and quick assembly.



We Care, Please Recycle

All aluminum frames and cases can be recycled.

We recommend that you assemble and repack your display prior to your first event. It is important to follow each step in the order indicated.

Proper Care & Maintenance of your Instand Display

- Store display upright at room temperature
- Do not subject to extreme heat or cold
- Do not leave display in direct sunlight or trunk of auto
- Return display to room temperature before handling
- Avoid extreme bending of Panels or permanent creasing will occur
- Use fabric brush to remove dust from FabriColor Panels

Setting Up Your Display

REMEMBER –

Read the complete instructions about your Instand product before assembling. If you need additional assistance or have any questions, please call the nearest Nomadic LifeLine.

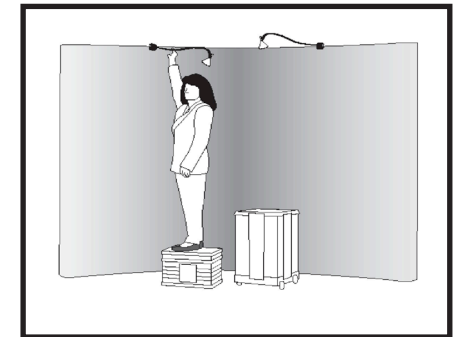
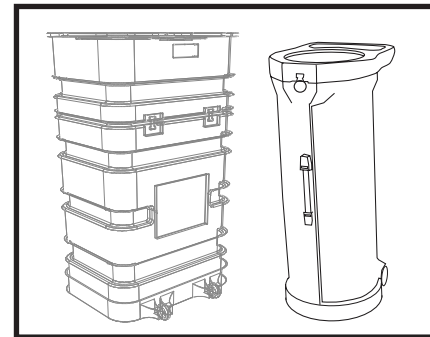
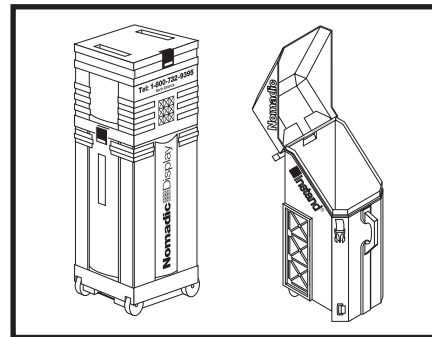

Rolluxe Case top serves as a built-in step stool to facilitate hanging and adjusting lights or graphics.

Setting Up Your Display



Place frame with red studs facing front.

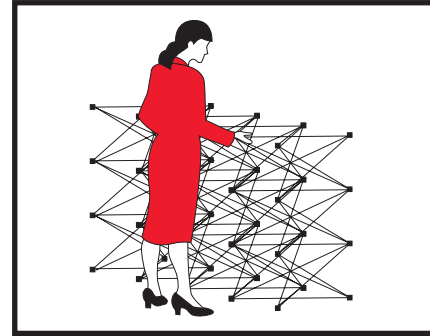

Grasp two top center hubs and lift frame open to shoulder height. Handle frame at hubs only.

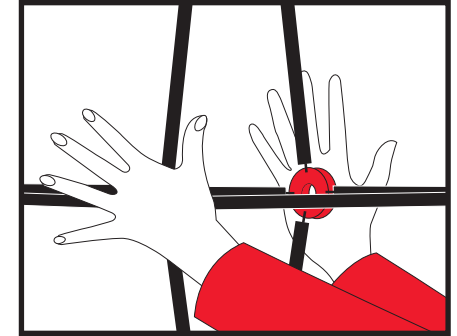

Press front and back hubs in the center of the frame until Instand locks into position. (Front and back hubs do not meet.)*

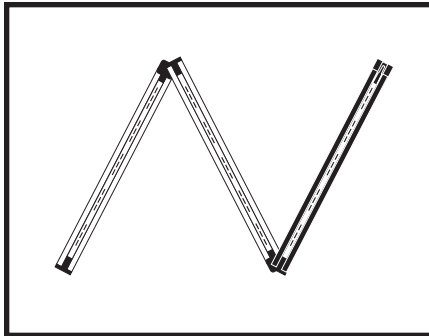

Unfold connected strut insuring magnets are facing the same direction...

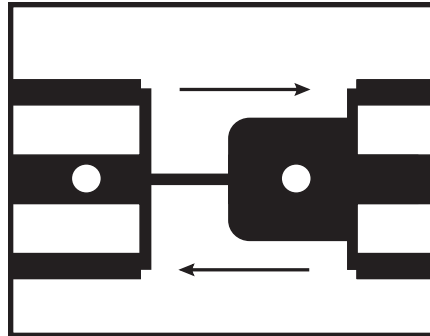

...and connect bottom two sections by joining as illustrated.

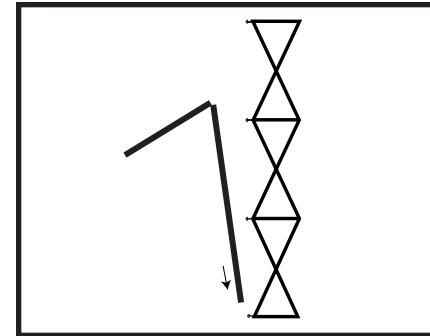

Slide bottom of connected strut onto the red stud at the bottom of the frame.

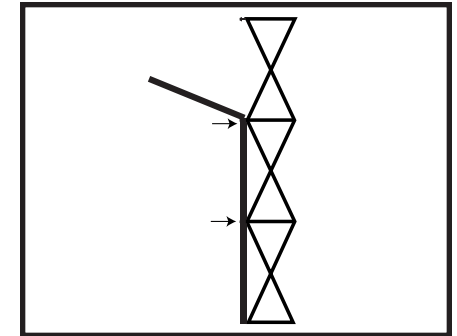

Snap next two connectors onto studs on frame.

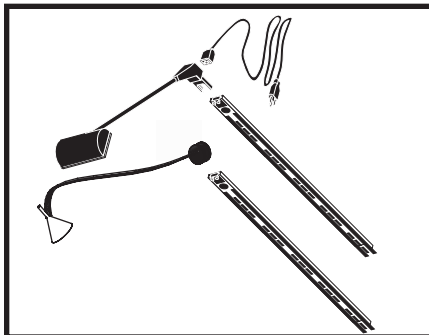

Attach lights to top of struts. Swivel fixtures to adjust position. Run cord behind display.

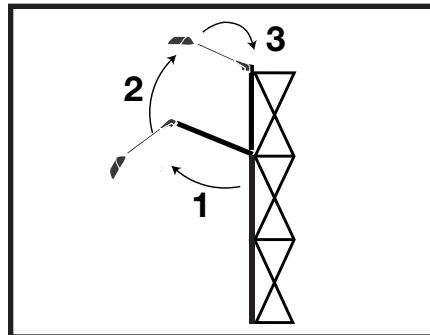

Rotate top section of strut up and slide down onto top stud.

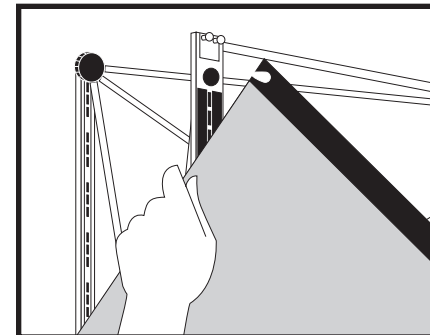

Hang all top panels and full size panels first. Lift onto studs atop frame. Hook one side then the other. Gradually release downward to bond magnets.



Bow endcaps and lift onto studs atop both sides of frame. For hinged panels hook one side then the other. Slide hands along length of panel to bond magnets.

Rolluxe Case

To remove top and set a new combination

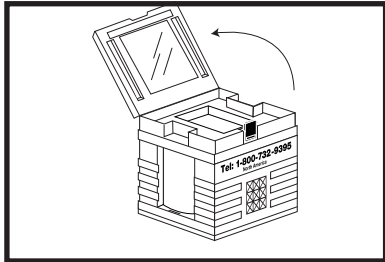

To open lid set your combination at "000".
To set a new combination...

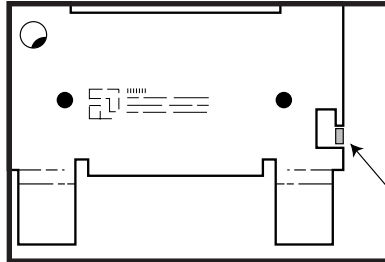

...look at the back of the lock between the latch and the case to locate the silver change lever.

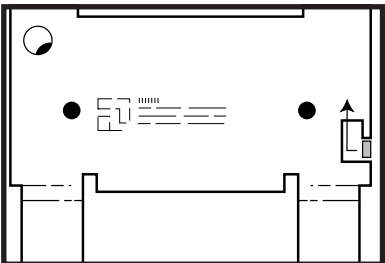

Use a hard object to push the silver change lever in towards the center of the lock and then up towards the lid.

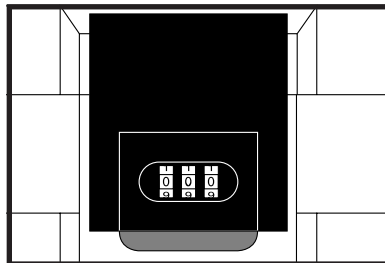

Set your new combination by turning the dials downward on the front of the lock

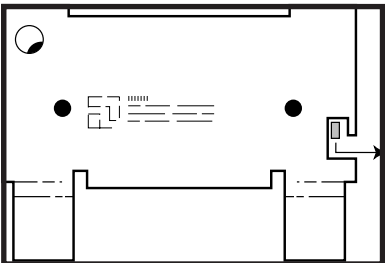

Return the silver change lever to its original position. Your new combination is now set.

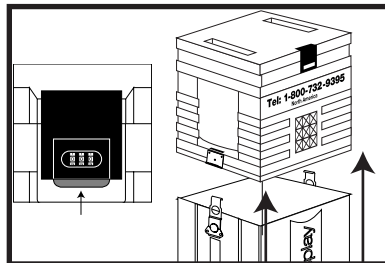

Press red button to release side latches and remove the top. **Note:** You may want to change all combinations to match.

REMEMBER-

Write your personalized combination down for your records and provide it to your I & D company prior to shipping the display.

To use built-in step stool

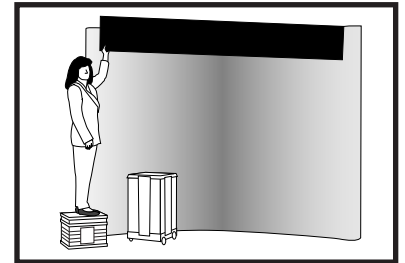

Rolluxe Case top serves as a built-in step stool to facilitate hanging graphics.



Make sure that step stool is on a level floor.



Do not wear high heels on step stool.



Step surface may be slippery when wet.

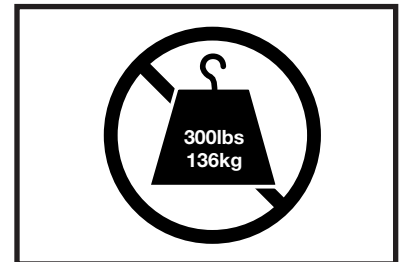

Do not place more than 300 lbs / 136 kg on step stool.

To close and move Rolluxe case

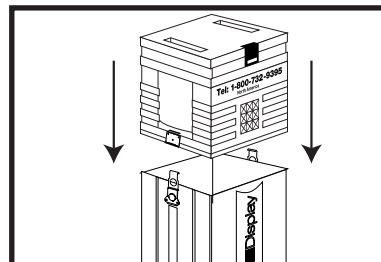

Align handle with wheels, snap and lock exterior latches. Scroll down the combination locks.

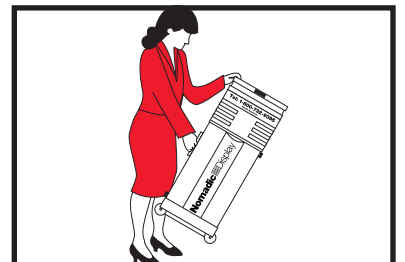

Grip top handle with one hand and the retractable handle with the other to lift case. Remember to always bend your knees.

Remove all accessories

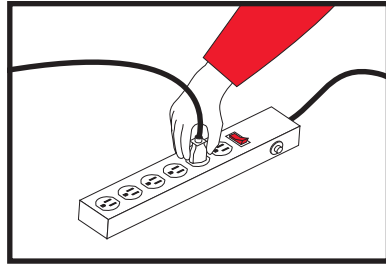

Switch off and unplug all lights.
Allow them to cool.



Gently remove and roll up all
surface graphics.

Dismantling Instructions

Remove and roll up
FabriColor and
Photomural Strips:

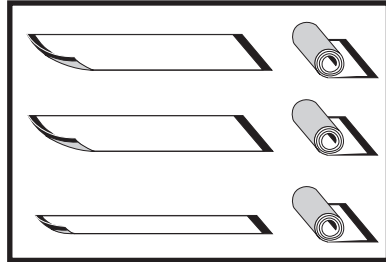

Roll individual **Ribbed** Panels fabric side
out. Roll Fronrunner End Caps fabric
side out.

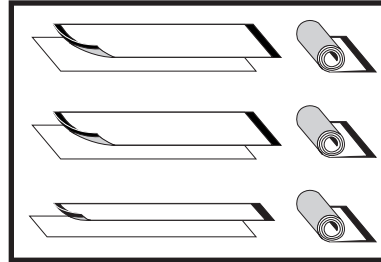

Roll individual **Smooth** fabric or
Graphic Panels with liners in between
and roll fabric/image side out. Repeat
same for End Caps.

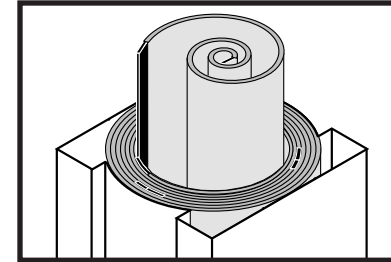

Put rolled panels into case one at a time and
one inside another. The top stiffener of one
panel should touch the bottom stiffener of
the previous panel. Stack Endcaps two high.

Remove Magnetic Struts
and Collapse Frames:

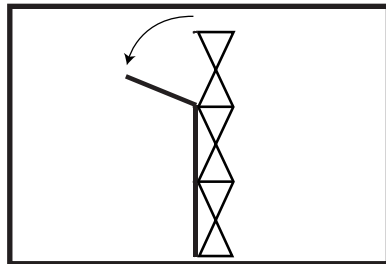

Lift top section of strut up. rotate down.
Remove all lights.

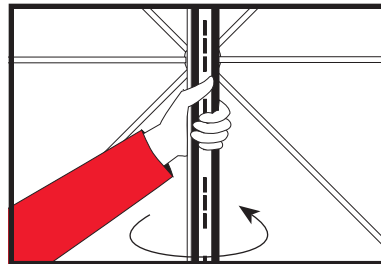

Twist strut to unsnap from frame.

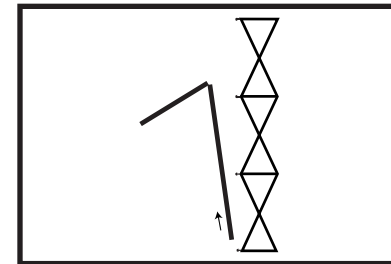

Lift bottom of strut off bottom stud.

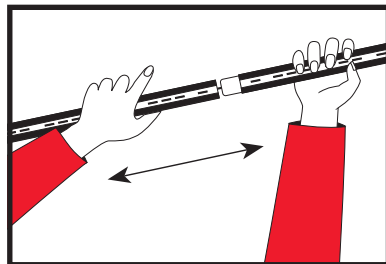

Pull strut sections apart.

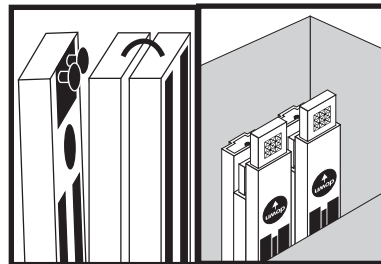

Fold lengthwise ensuring that pegs at
top of strut face inward. Place connected
struts upside down in case.

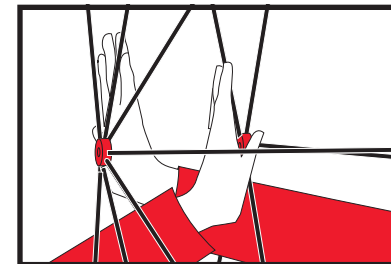

Push on middle hub at back of frame while
pushing on corresponding front hub. Instand
will sink to the floor. Handle frame at hubs.

Setting Up Your Rolluxe Counter

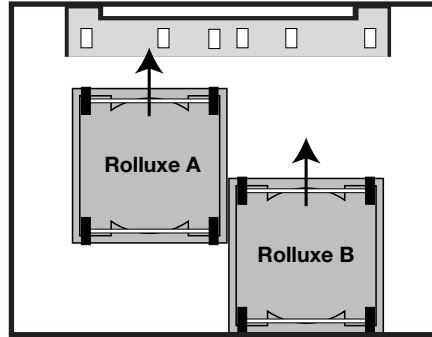

Place one wheel stop on the floor and roll the cases on to it.

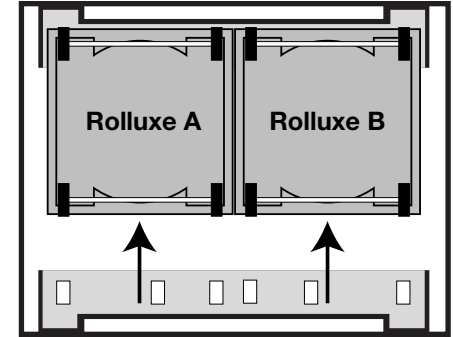
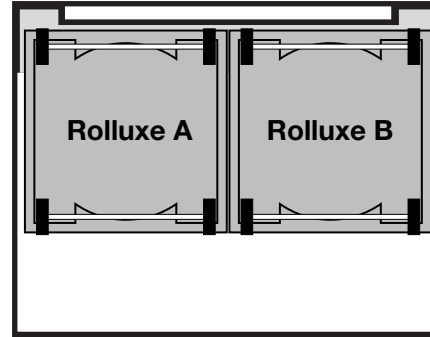

Place second wheel stop on the floor under the opposite wheels.

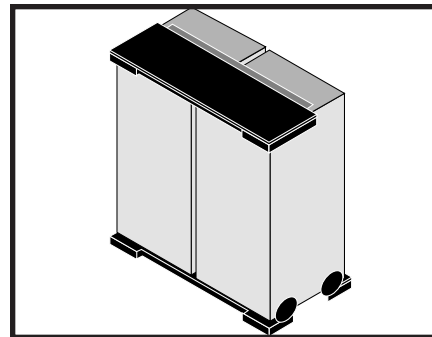

Place the plastic top shelf half with exposed magnetic lip on top of the case.

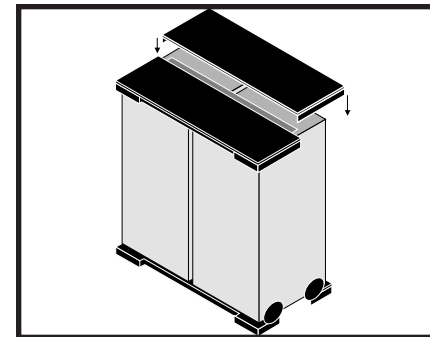

Place the second plastic top shelf half on top of the cases ensuring magnets are aligned and engaged.

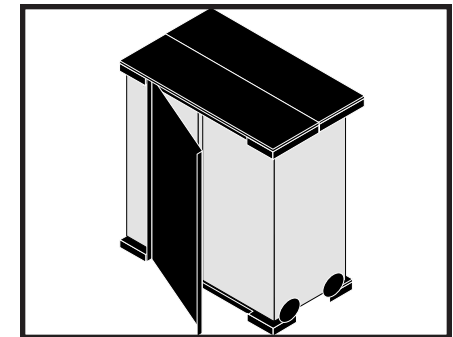

Attach front fabric panel to Velcro at top and bottom. Form a straight line with magnets on front panel before attaching end caps.

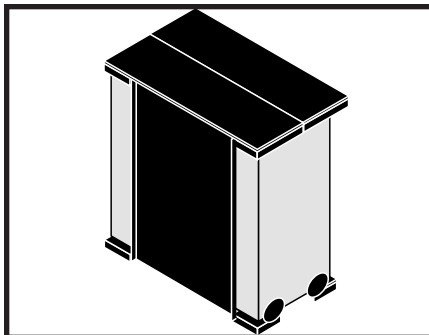

Repeat on opposite side.

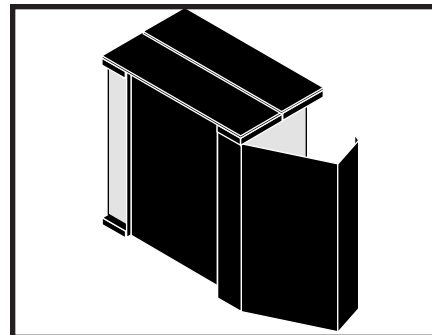

Attach fabric end cap by starting at corner...

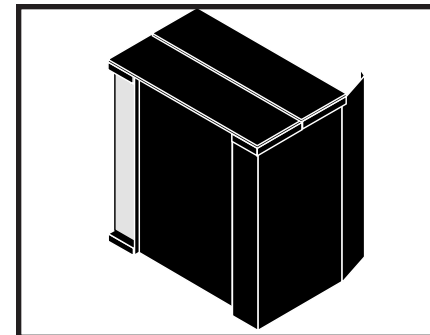

...wrap end cap along top edge then bottom edge. Slide hands along length of edge of end cap to bond magnets.

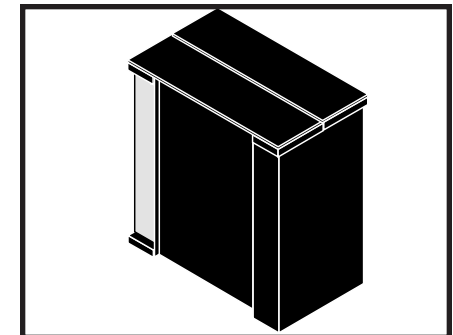

Repeat with last end cap. Counter load is 100 lbs / 46 kg; a heavier load may cause failure.