

**MODULAR  
TENSION FABRIC  
DISPLAY SYSTEM  
NAVIGATOR™**

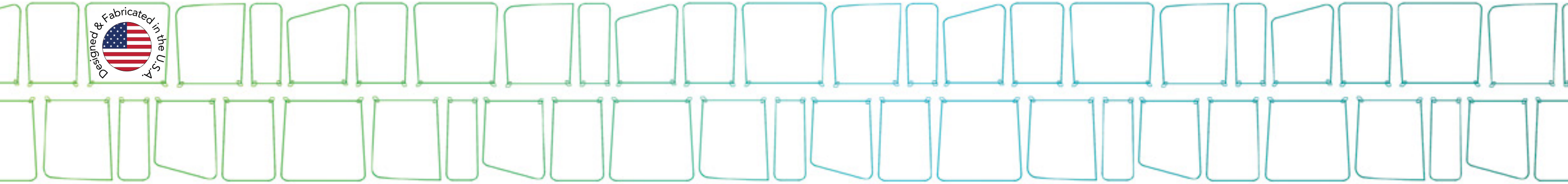
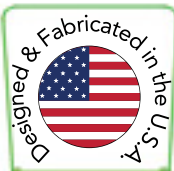

# NAVIGATOR™

TENSION FABRIC / TUBE STRUCTURES

## Using Your Setup Instructions

The Standing Sign Setup Instructions are created specifically for your configuration. They include an exploded view of the frame which is sequentially numbered. We encourage you to study the instructions before attempting to assemble your exhibit.

Connections are kept very simple: no tools for frame, 7/32 allen wrench for baseplates. Everything assembles with push-button connectors and pre-connected horizontal sections.

## Cleaning and Packing Your Display

- 1) Use care when cleaning aluminum extrusion or acrylic inserts. Use only non-abrasive cleaners.
- 2) Retain all packing material. It will make re-packing much easier and will reduce the likelihood of shipping damage.

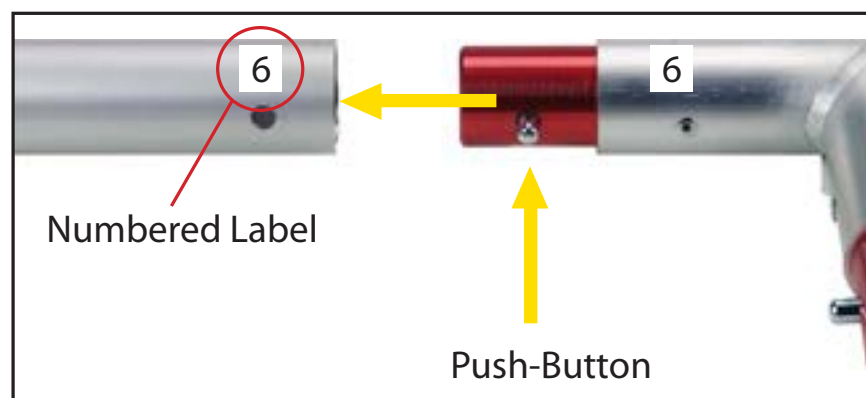

Connections are made by holding the button down and sliding the red tube into opposing tube until the connection is made. To disassemble push button and pull or twist extrusions apart.

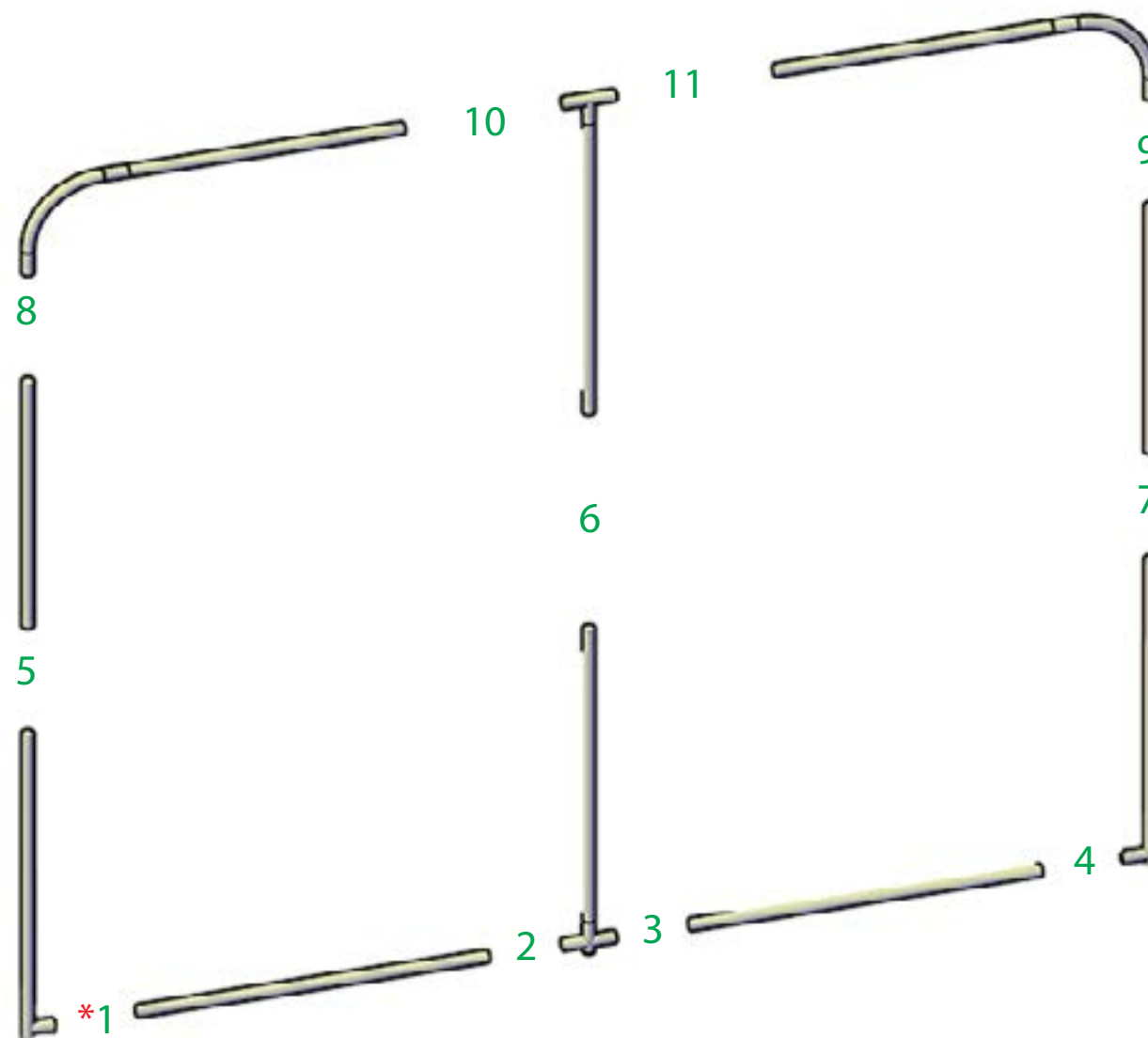
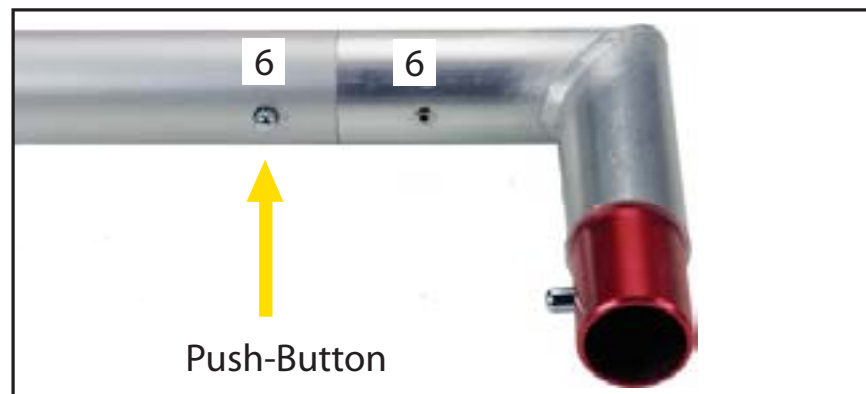

## Steps:

- 1.) Connect **GREEN** numbered pieces together in numerical order **1-11**.
- 2.) Apply graphics and zipper closed.

# NAVIGATOR™

TENSION FABRIC / TUBE STRUCTURES

## Using Your Setup Instructions

The Standing Sign Setup Instructions are created specifically for your configuration. They include an exploded view of the frame which is sequentially numbered. We encourage you to study the instructions before attempting to assemble your exhibit.

Connections are kept very simple: no tools for frame, 7/32 allen wrench for baseplates. Everything assembles with push-button connectors and pre-connected horizontal sections.

## Cleaning and Packing Your Display

- 1) Use care when cleaning aluminum extrusion or acrylic inserts. Use only non-abrasive cleaners.
- 2) Retain all packing material. It will make re-packing much easier and will reduce the likelihood of shipping damage.

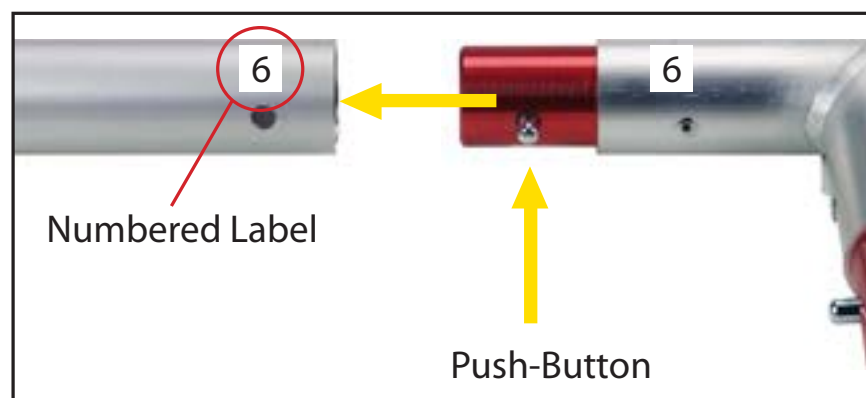

Connections are made by holding the button down and sliding the red tube into opposing tube until the connection is made. To disassemble push button and pull or twist extrusions apart.

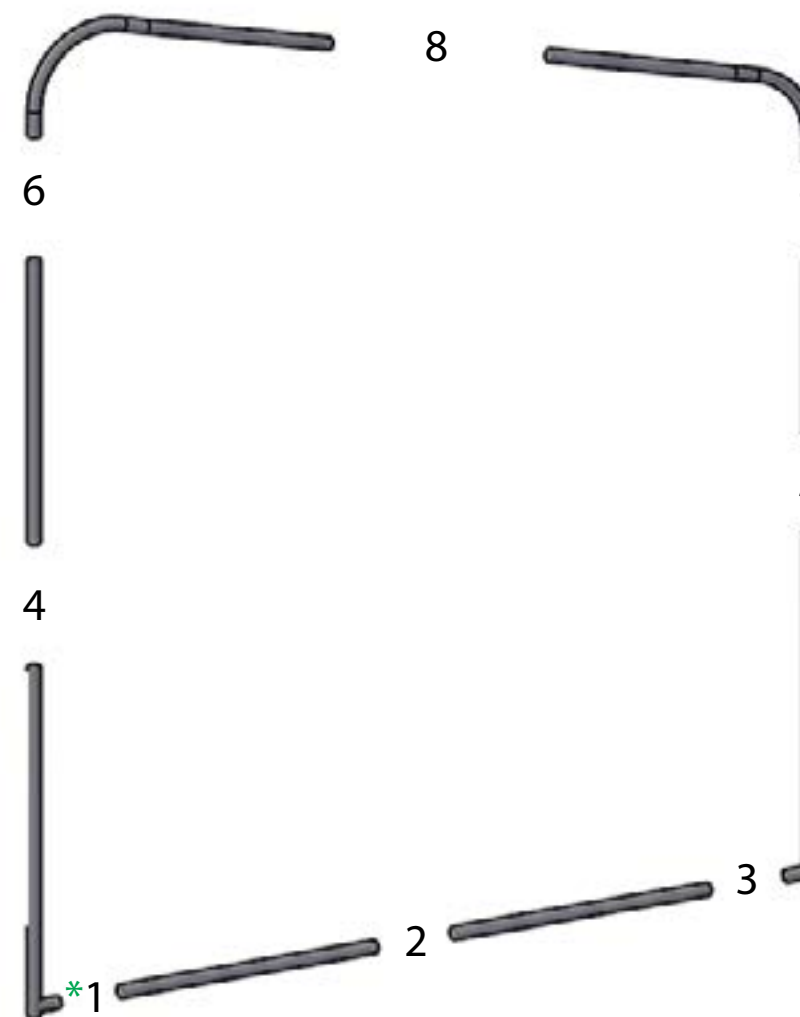
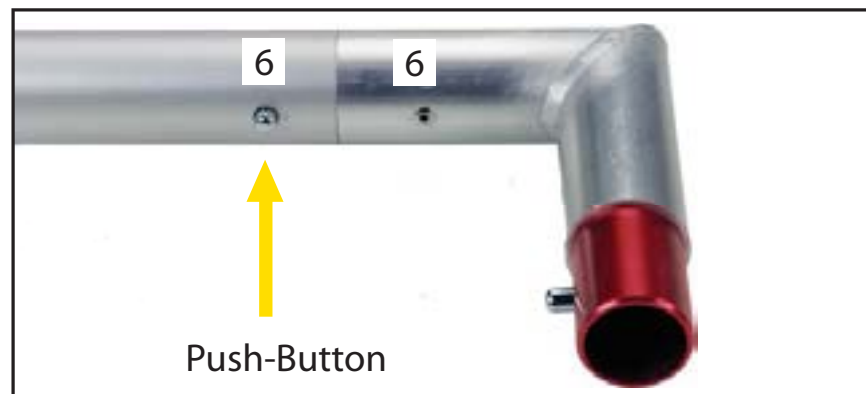

## Steps:

- 1.) Connect **BLACK** numbered pieces together in numerical order **1-8**.
- 2.) Apply graphics and zipper closed.

# MDS 002 Kit Setups

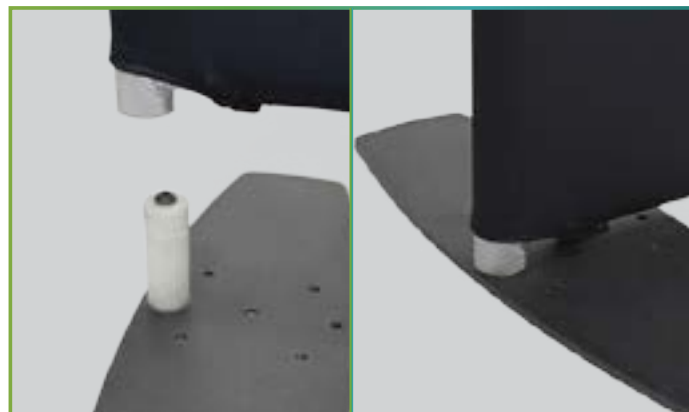

Slide each frame end onto correct numbered baseplate and post. Slide down till frame is flush to baseplate. (see Diag 1 to right)

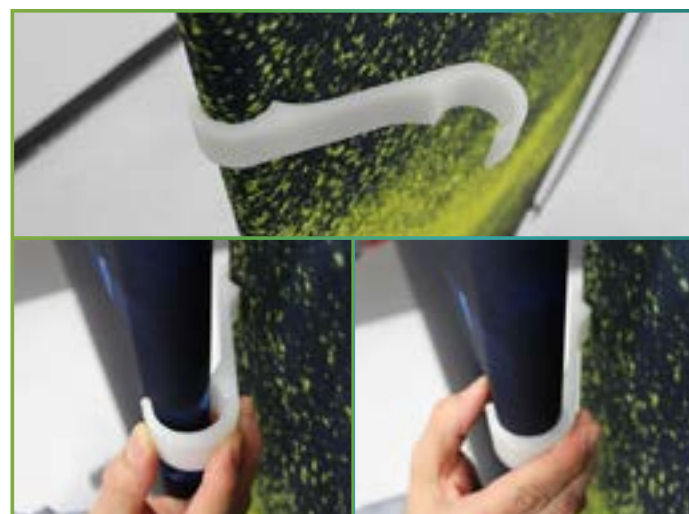

Align frames into place and clamp S-frame connector to side of the frames. Continue until display is complete. Place S connector 60" from floor.



Diag. 1

BASEPLATE LOCATION

